

GH04

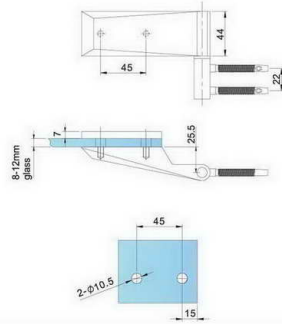

lift off hinge for glass door
stainlee steel or Aluminium material available



GH05



stainlee steel hinge for glass door

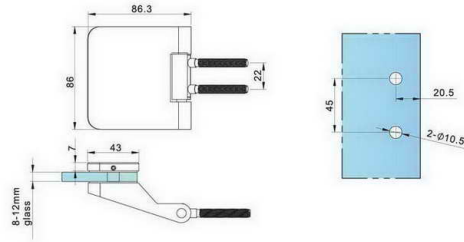

GH06



zinc alloy hinge for glass door

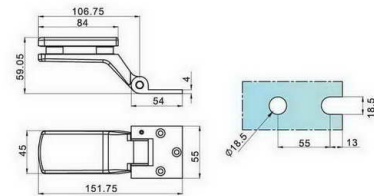

GL101



glass lock with handle, for sliding door

- 1.glass door to wall frame
- 2.glass door to glass panel

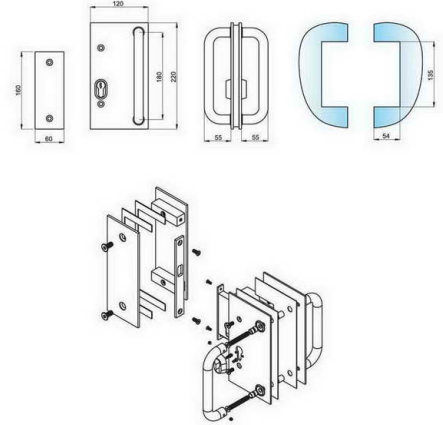

GL102



glass lock for sliding door

- 1.glass door to wall frame
- 2.glass door to glass panel

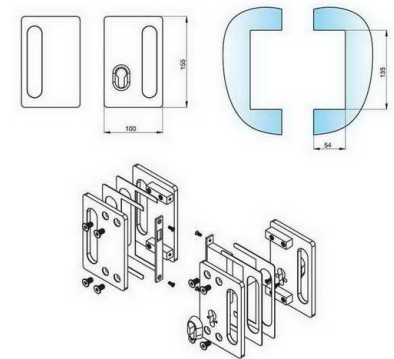

GL103

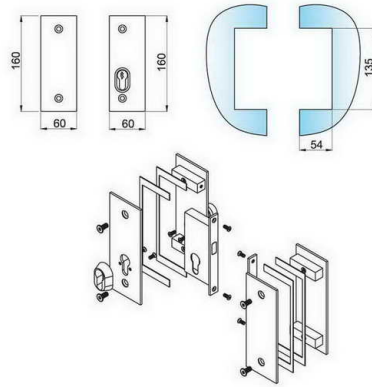

glass lock for swing door
1.glass door to wall frame
2.glass door to glass panel

GL104

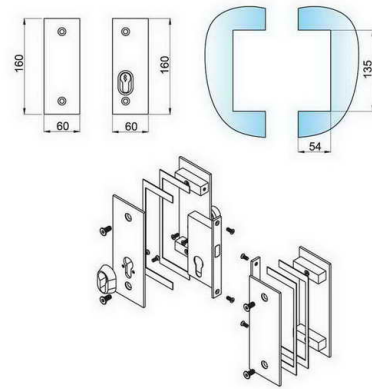

glass lock for sliding door
1.glass door to wall frame
2.glass door to glass panel



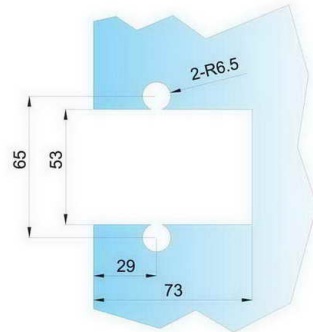
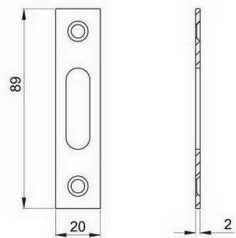
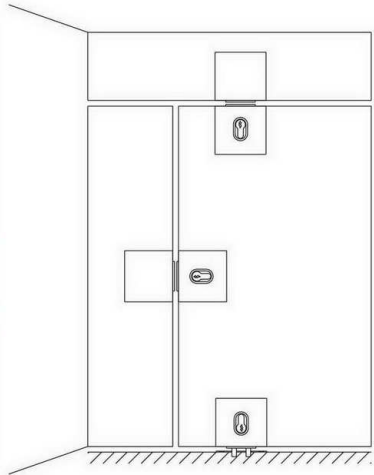

GL105

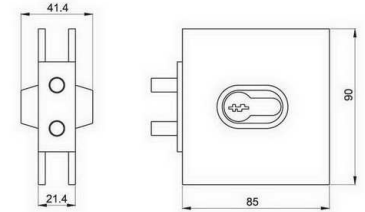

stainless steel glass lock

GL106

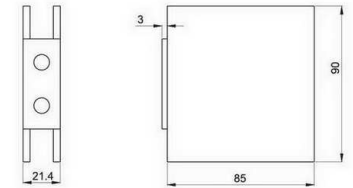

stainless steel strike box

GL107

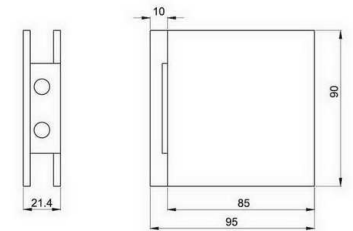

stainless steel strike box with stop

GL201

Art No	Size
GL201/1200	1200mm
GL201/1500	1500mm
GL201/1800	1800mm
GL201/2000	2000mm
GL201/2400	2400mm

Note:
 . When order pls inform us handle for single door or double door
 . Cylinder can be changed

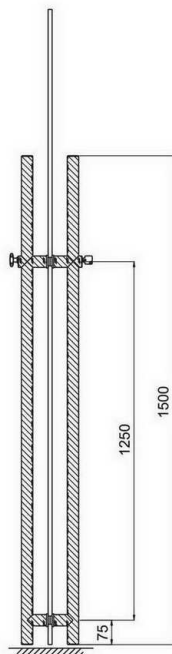

Single Door

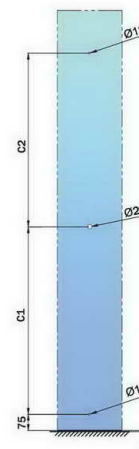
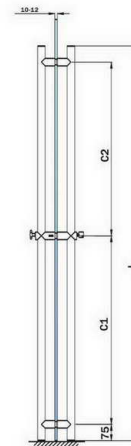
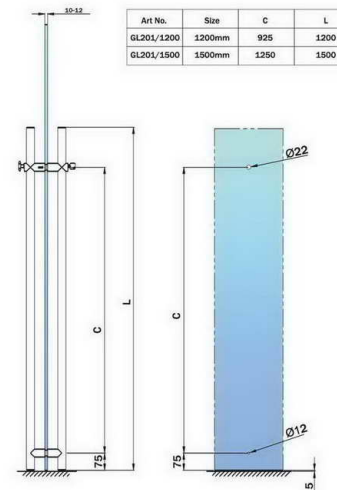
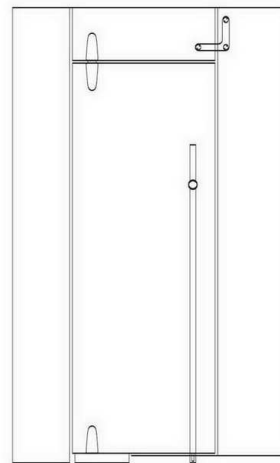

Art No.	Size	C1	C2	L
GL201/1800	1800mm	925	725	1800
GL201/2000	2000mm	925	925	2000
GL201/2400	2400mm	1175	1075	2400

PC010

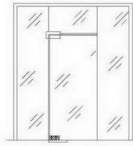
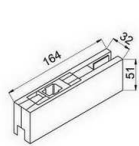

pivot hole option

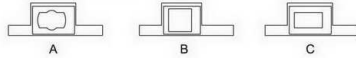

bottom patch clamp

PC050

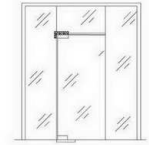
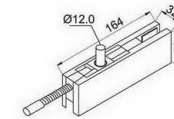

top patch clamp for upper glass wall mounting

PC020

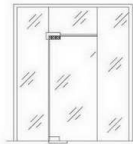
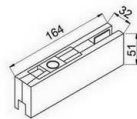

top patch clamp

PC060

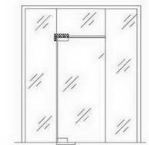
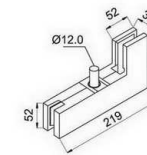

L shape top patch clamp

PC030

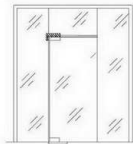
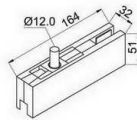

top patch clamp for upper glass

PC070

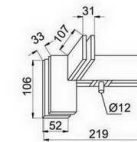

top patch clamp, three corner

PC040

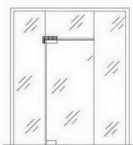
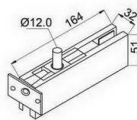

top patch clamp for upper glass wall mounting

PC013

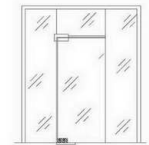
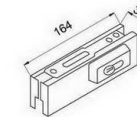

patch lock