

L021

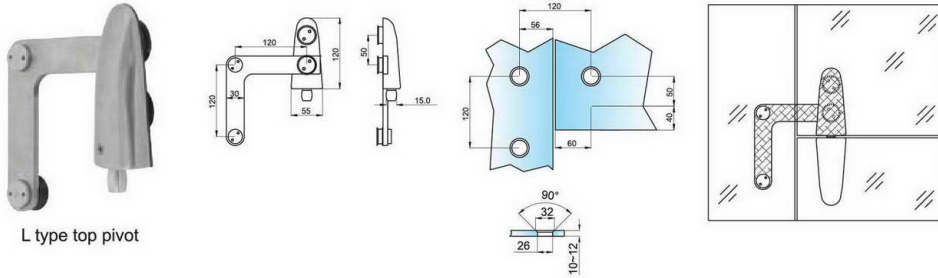

L type top pivot

L025

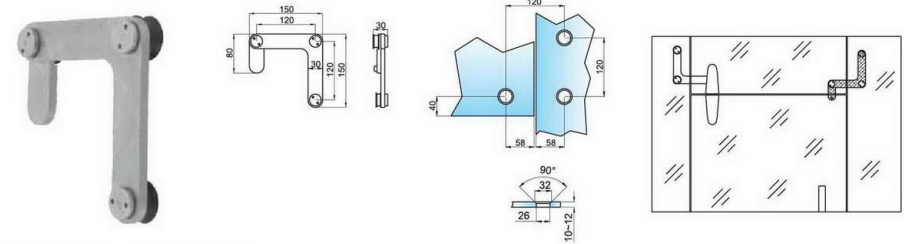

L fixing connector with door stopper

L022

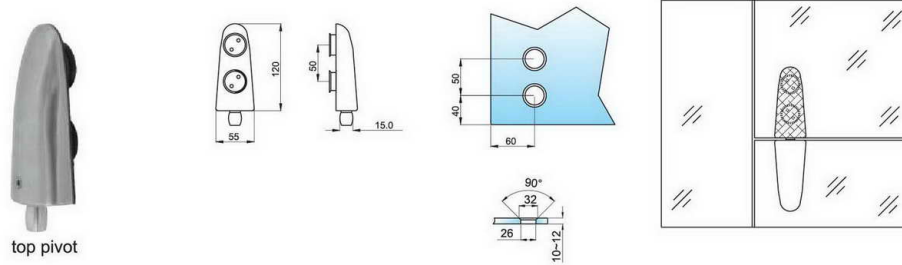

top pivot

L026

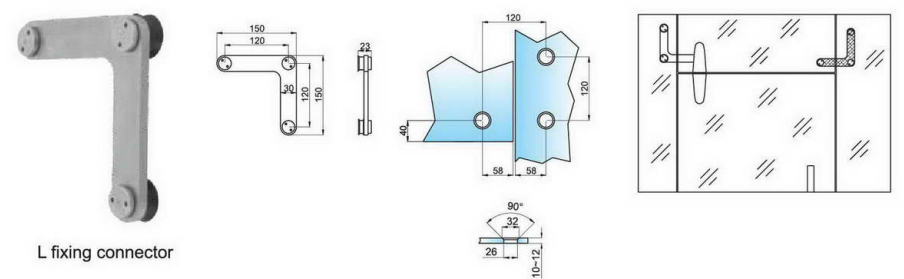

L fixing connector

L023

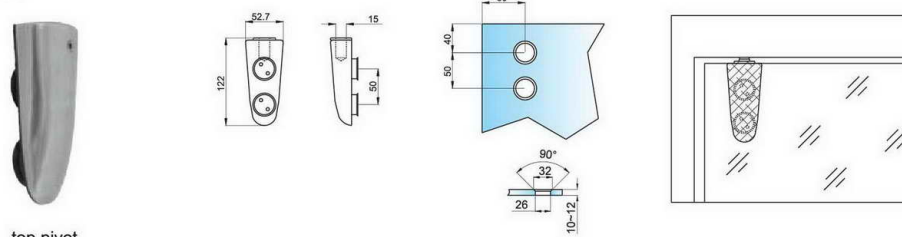

top pivot

L027

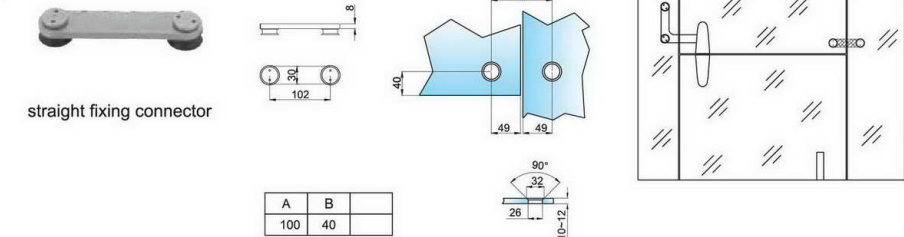

straight fixing connector

L024

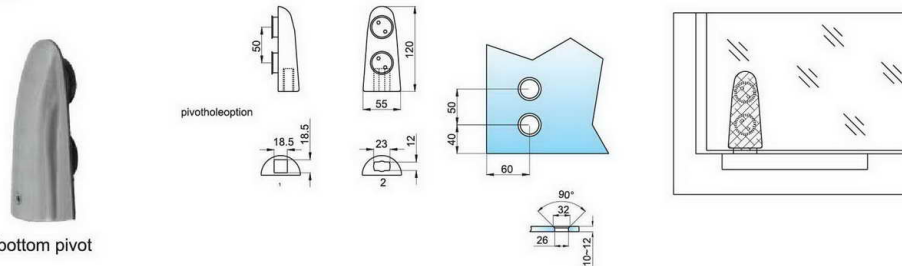

bottom pivot

L028

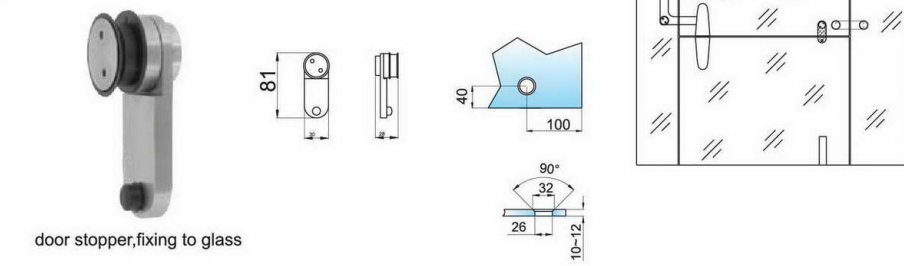

door stopper, fixing to glass

L029



L fixing connector

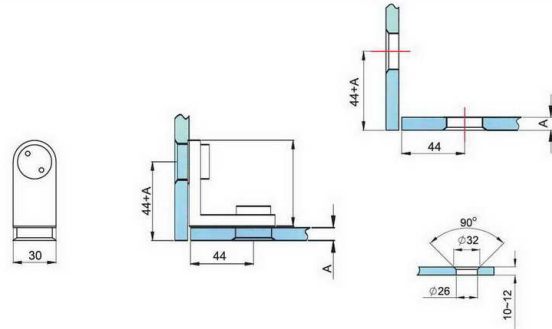

L030



fixing connector floor to glass, adjustable

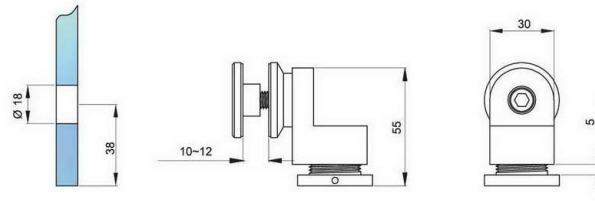

L031



door stopper, fixing to frame

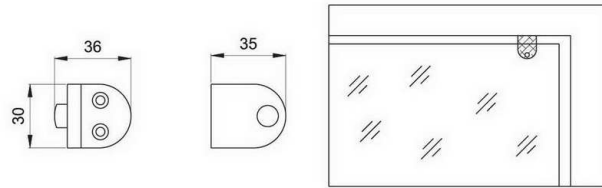

L032



glass door bolt glass to floor

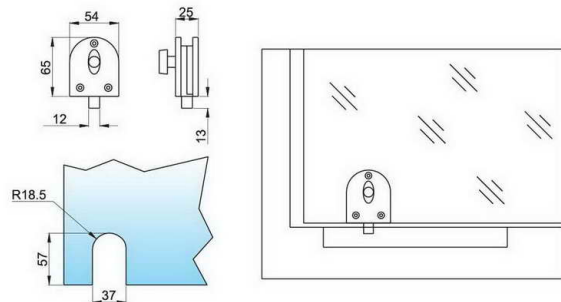

GC301



glass fixing connector wall to glass, one side angle adjustable

Art No	Rob
GC301/52.5	52.5mm
GC301/60	60mm
GC301/82	82mm
GC301/103	103mm

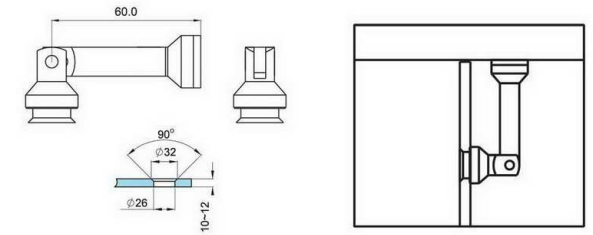

GC302



glass fixing connector wall to glass, both side angle adjustable

Art No	Rob
GC302/52.5	52.5mm
GC302/60	60mm
GC302/82	82mm
GC302/103	103mm

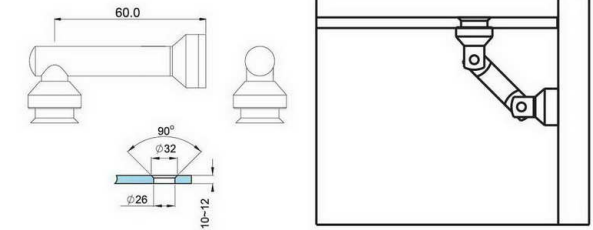

GC303



glass fixing connector glass to glass, double angle adjustable

Art No	Rob
GC303/52.5	52.5mm
GC303/60	60mm
GC303/82	82mm
Gc303/103	103mm

